



## Glass Railing Systems

## Company Profile

### About us

Allmark - Railing and Hardware is one of the leading Railing manufacturers in India. We have been steadily growing and satisfying the architectural building industry for years. Many of our clients are builders, however, we also serve a great percentage of dealer, distributor, private residents as well.

The initial start of your project is first discussed in a “one on one” meeting with you and or your consultant. All the preliminary details and materials needed to complete your exquisite Railing will be discussed during the first consultation. During this time segment, we will define what dimensions are to be specified and also incorporate the design style with the architecture of your building or dwelling before any work begins.

Allmark are Railing specialists that have been providing high quality, custom built staircase and balcony railings since 2013. Mr. Sourav Chokhani the proprietor is involved on with every project. Everything from custom designing, fabrication, installation on stairs and balconies.

Allmark - Railing and Hardware prides themselves on crafting only high quality products. Every project is individualized with a wide scope of options available with value engineering. We work with numerous types of materials to provide you with a unique product that you can be proud of. Our team consists of skilled craftsmen that are focused on delivering your project on time and on budget while working alongside other professionals such as architects, builders and designers.

Our finished custom-built staircase and railing will add beauty to your home. It will be one you can rely on for years to come. Give us a call today for your free estimate, we look forward to hearing from you!

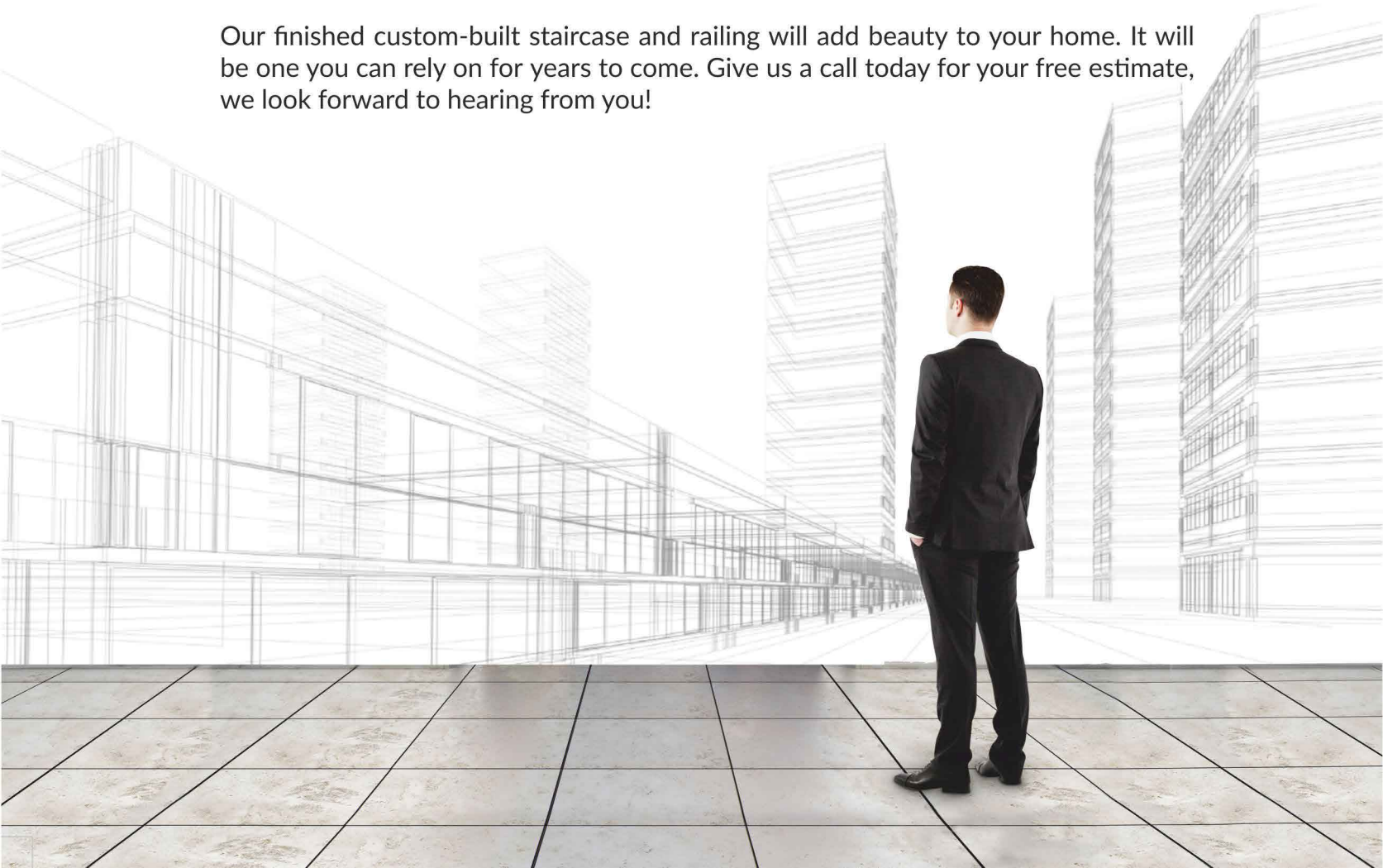

# INDEX

No.	Products	Page No.
1	AM-01 ORCHID	1
2	AM-02 SENSO	3
3	AM-03 PRIMO	4
4	AM-04 ROBUSTA	5
5	AM-05 DAPPER	6
6	AM-06 SQUAD	7
7	AM-07 FLAME	8
8	AM-08 APEX	9
9	AM-09 ZEST	11
10	AM-10 REGULAR FERRY	12
11	AM-11 TRIANGULAR FERRY	13
12	AM-12 BIG FERRY	15
13	AM-13 HAZEL	16
14	AM-14 UNO	17
15	AM-15 RAPTOR	18
16	AM-16 REGENCY	19
17	AM-17 SIDE MOUNT	20
18	AM-18 BLISS	21
19	AM-19 HORIZON	22
20	AM-20 T BRACKETO	23
21	AM-21 L BRACKETO	25
22	AM-22 ORCHID BRACKETO	26
23	AM-23 FERRY BRACKETO	27
24	AM-24 BIG FERRY BRACKETO	28
25	AM-25 PRIMO BRACKETO	29
26	AM-26 ATLAS BRACKETO	30
27	HANDRAIL OPTIONS	31

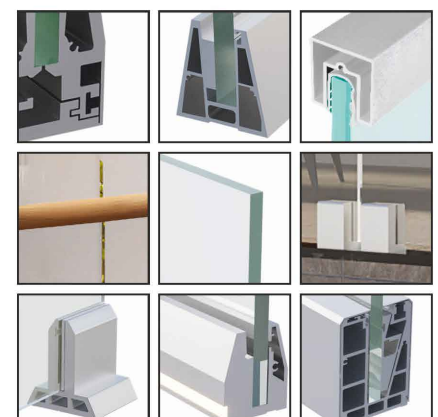



AM - 01 ORCHID



**Features**

- Rust Free
- Recyclable
- Low Maintenance
- Complete Modular
- Easy to clean

**Specification**

- Bracketed with Cover
- Floor Mounted
- Glass Height up to 1000mm
- Bracket Size : 70mm to 140 mm

**Glass**

- 10mm - 14mm Thick Glass  
(For other glass please revert)

**Available Finishes**

- Powder Coating
- Sand Blast
- Anodised
- Wooden Finish

# Glass Railing

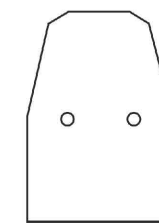

ENDCAP

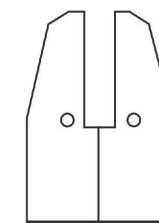

SLOTTED

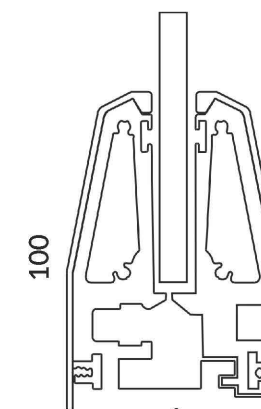

65





AM - 02 SENSO



**Features**

- Rust Free
- Recyclable
- Low Maintenance
- Complete Modular
- Easy to clean

**Specifications**

- Bracketed with Cover
- Floor Mounted
- Glass Height up to 900mm
- Bracket Size : 70mm to 140 mm

**Glass**

- 10mm - 12mm Thick Glass

**Available Finishes**

- Powder Coating
- Sand Blast
- Anodised
- Wooden Finish

**Glass Railing**



ENDCAP

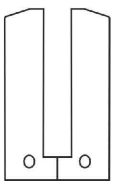

SLOTTED

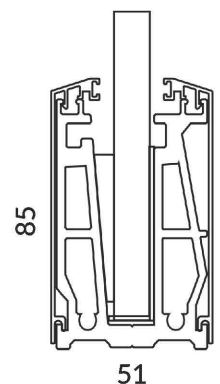

51

AM - 03 PRIMO



**Features**

- Rust Free
- Recyclable
- Low Maintenance
- Complete Modular
- Easy to clean

**Specification**

- Bracketed with Cover
- Floor Mounted
- Glass Height up to 1150mm
- Bracket Size : 70mm to 140mm

**Glass**

- 12mm - 17mm Thick Glass

**Available Finishes**

- Powder Coating
- Sand Blast
- Anodised
- Wooden Finish

# Glass Railing

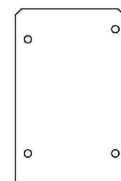

ENDCAP

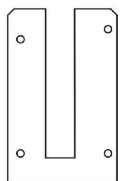

SLOTTED

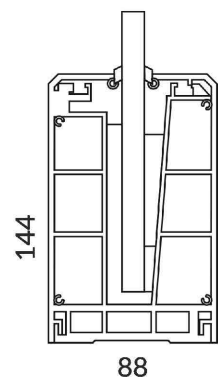



AM - 04 ROBUSTA



**Features**

- Rust Free
- Recyclable
- Low Maintenance
- Complete Modular
- Easy to clean

**Specification**

- Bracketed with Cover
- Floor Mounted
- Glass Height up to 1100mm
- Bracket Size : 70mm to 140mm

**Glass**

- 12mm - 17mm Thick Glass

**Available Finishes**

- Powder Coating
- Sand Blast
- Anodised
- Wooden Finish

**Glass Railing**

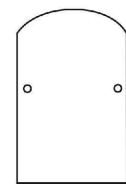

ENDCAP

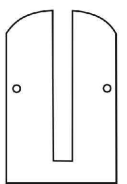

SLOTTED

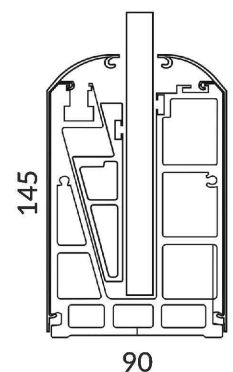

90

AM - 05 DAPPER



**Features**

- Rust Free
- Recyclable
- Low Maintenance
- Complete Modular
- Easy to clean

**Specification**

- Continous Profile
- Floor Mounted
- Glass Height up to 950mm

**Glass**

- 8mm - 14mm Thick Glass

**Available Finishes**

- Powder Coating
- Sand Blast
- Anodised
- Wooden Finish

**Glass Railing**

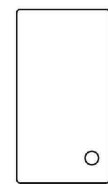

ENDCAP

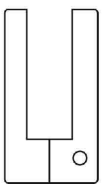

SLOTTED

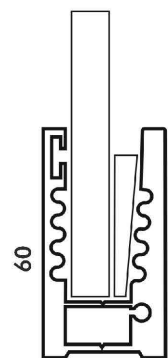

30



AM - 06 SQUAD



**Features**

- Rust Free
- Recyclable
- Low Maintenance
- Complete Modular
- Easy to clean

**Specification**

- Continous Profile
- Floor Mounted
- Glass Height up to 900mm

**Glass**

- 10mm - 12mm Toughened Glass

**Available Finishes**

- Powder Coating
- Sand Blast
- Anodised
- Wooden Finish

**Glass Railing**

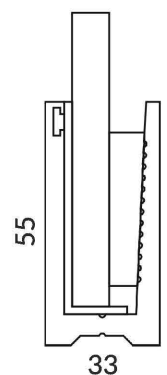
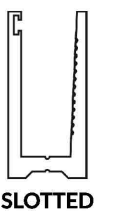

AM - 07 FLAME

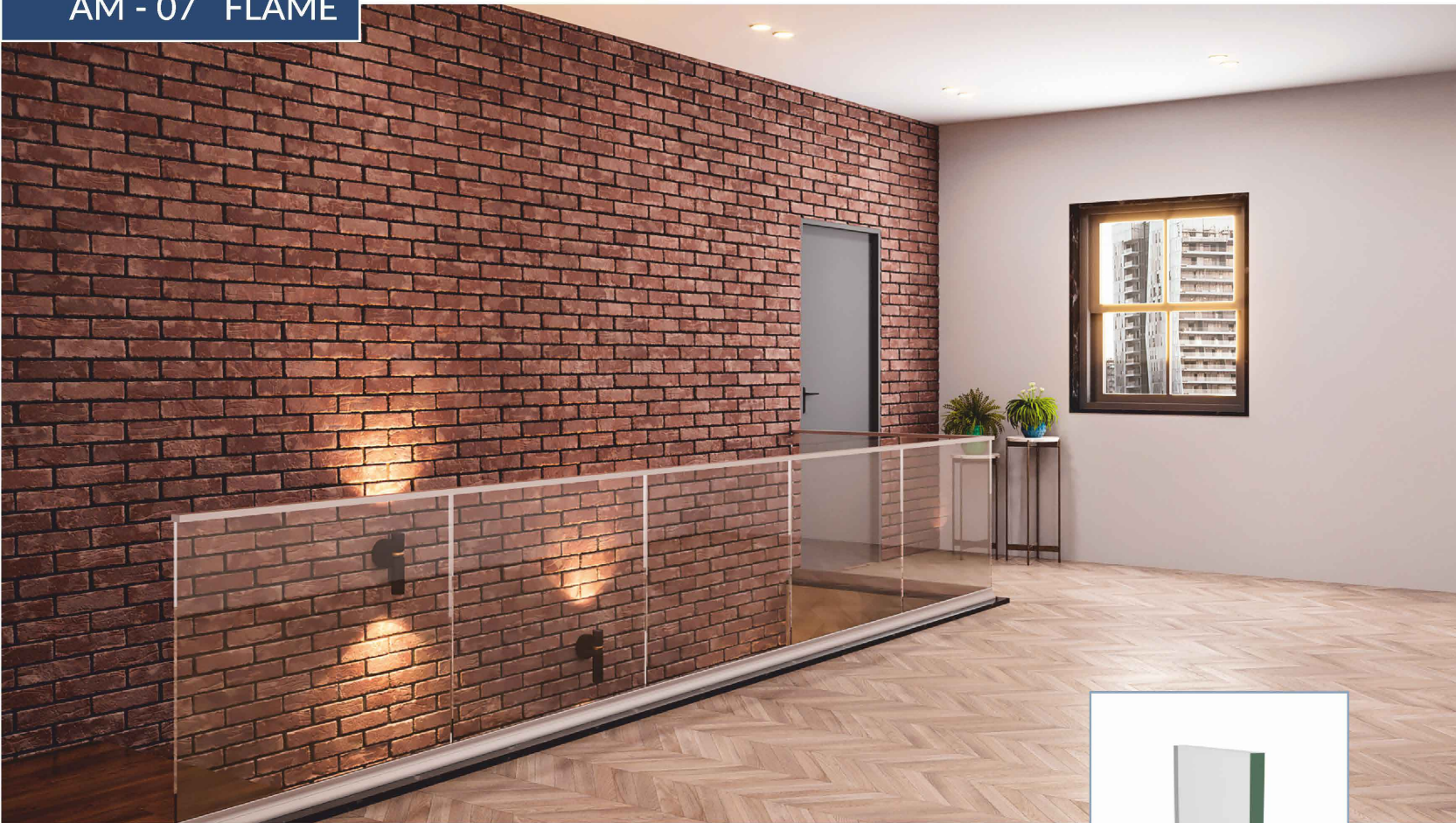

**Features**

- Rust Free
- Recyclable
- Low Maintenance
- Complete Modular
- Easy to clean

# Glass Railing



**Specification**

- Continuous Profile
- Floor Mounted
- Glass Height up to 950mm

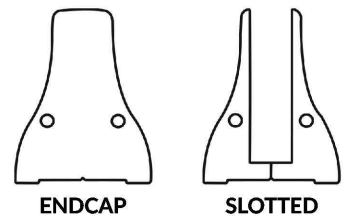

**Glass**

- 10mm - 12mm Toughened Glass

**Available Finishes**

- Powder Coating
- Sand Blast
- Anodised
- Wooden Finish

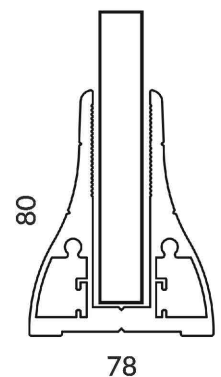



AM - 08 APEX



- Features**
- Rust Free
  - Recyclable
  - Low Maintenance
  - Complete Modular
  - Easy to clean

- Specification**
- Continous Profile
  - Floor Mounted
  - Glass Height up to 1100mm

- Glass**
- 12mm - 14mm Toughened Glass

- Available Finishes**
- Powder Coating
  - Sand Blast
  - Anodised
  - Wooden Finish

## Glass Railing

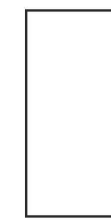

ENDCAP

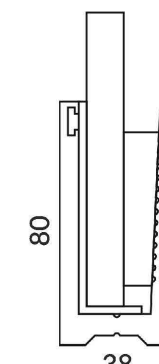

AM - 09 ZEST



- Features**
- Rust Free
  - Recyclable
  - Low Maintenance
  - Complete Modular
  - Easy to clean

- Specification**
- Continous Profile
  - Floor Mounted
  - Glass Height up to 900mm

- Glass**
- 10mm - 14mm Thick Glass  
(For other glass please revert)

- Available Finishes**
- Powder Coating
  - Sand Blast
  - Anodised
  - Wooden Finish

# Glass Railing

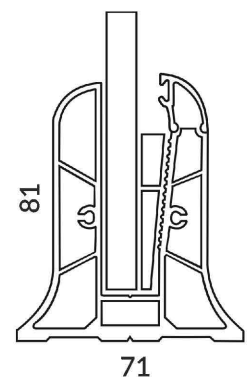
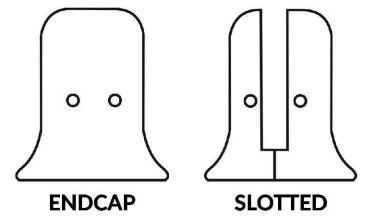
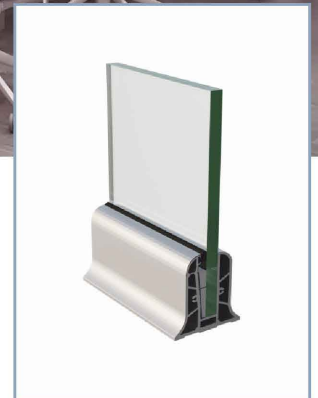



AM - 10 REGULAR FERRY



**Features**

- Rust Free
- Recyclable
- Low Maintenance
- Complete Modular
- Easy to clean

**Specification**

- Continous Profile
- Floor Mounted
- Glass Height up to 950mm

**Glass**

- 10mm - 12mm Toughened Glass

**Available Finishes**

- Powder Coating
- Sand Blast
- Anodised
- Wooden Finish

**Glass Railing**

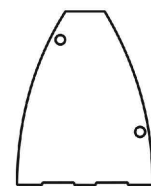

ENDCAP

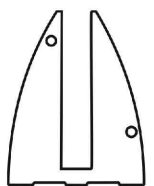

SLOTTED

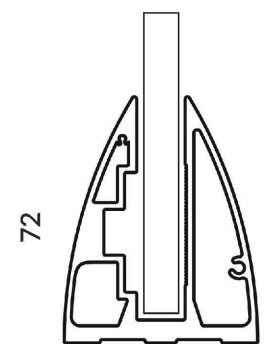

57



AM - 11 TRIANGULAR FERRY



**Features**

- Rust Free
- Recyclable
- Low Maintenance
- Complete Modular
- Easy to clean

**Specification**

- Continous Profile
- Floor Mounted
- Glass Height up to 950mm

**Glass**

- 10mm - 14mm Thick Glass

**Available Finishes**

- Powder Coating
- Sand Blast
- Anodised
- Wooden Finish

**Glass Railing**

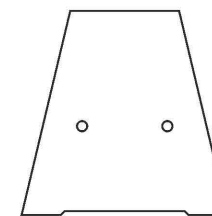

ENDCAP

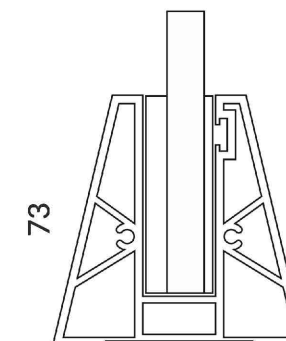

65





AM - 12 BIG FERRY



**Features**

- Rust Free
- Recyclable
- Low Maintenance
- Complete Modular
- Easy to clean

# Glass Railing



**Specification**

- Continuous Profile
- Floor Mounted
- Glass Height up to 950mm

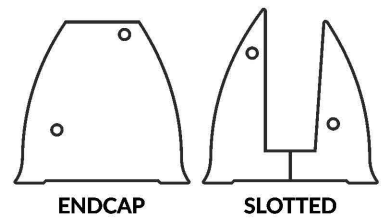

**Glass**

- 10mm - 14mm Thick Glass

**Available Finishes**

- Powder Coating
- Sand Blast
- Anodised
- Wooden Finish

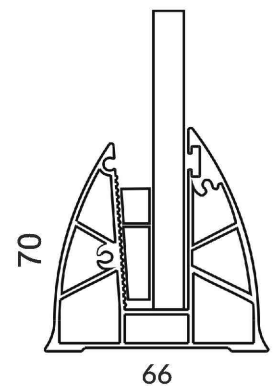

AM - 13 HAZEL



**Features**

- Rust Free
- Recyclable
- Low Maintenance
- Complete Modular
- Easy to clean
- Can Be Concealed

**Specification**

- Continuous Profile
- Floor Mounted
- Glass Height up to 1000mm

**Glass**

- 10mm - 14mm Thick Glass

**Available Finishes**

- Powder Coating
- Sand Blast
- Anodised
- Wooden Finish

**Glass Railing**

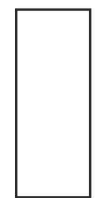

ENDCAP

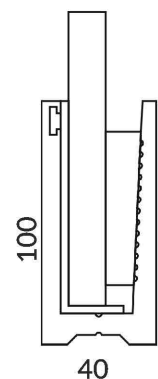



AM - 14 UNO



**Features**

- Rust Free
- Recyclable
- Low Maintenance
- Complete Modular
- Easy to clean
- Can Be Concealed

**Specification**

- Continous Profile
- Floor Mounted
- Glass Height up to 1200mm

**Glass**

- 12mm - 18mm Thick Glass

**Available Finishes**

- Powder Coating
- Sand Blast
- Anodised
- Wooden Finish

**Glass Railing**



ENDCAP

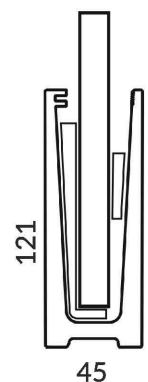

121

45

AM - 15 RAPTOR



**Features**

- Rust Free
- Recyclable
- Low Maintenance
- Complete Modular
- Easy to clean

**Specification**

- Continous Profile
- Floor Mounted
- Glass Height up to 1200mm

**Glass**

- 12mm - 18mm Thick Glass

**Available Finishes**

- Powder Coating
- Sand Blast
- Anodised
- Wooden Finish

**Glass  
Railing**



ENDCAP

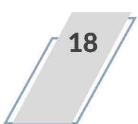
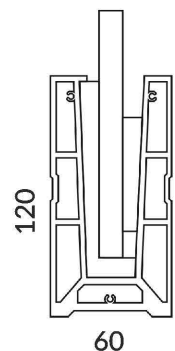



AM - 16 REGENCY



**Features**

- Rust Free
- Recyclable
- Low Maintenance
- Complete Modular
- Easy to clean
- Pressure Plates

**Specification**

- Continuous Profile
- Floor Mounted
- Glass Height up to 1200mm

**Glass**

- 12mm - 19mm Thick Glass

**Available Finishes**

- Powder Coating
- Sand Blast
- Anodised
- Wooden Finish

**Glass Railing**

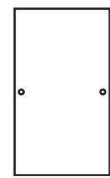

ENDCAP

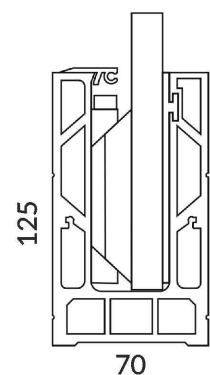

AM - 17 SIDE MOUNT



**Features**

- Rust Free
- Recyclable
- Low Maintenance
- Complete Modular
- Easy to clean

**Specification**

- Bracketed with Cover
- Side Mounted
- Glass Height up to 1200mm

**Glass**

- 12mm - 17mm Toughened Glass

**Available Finishes**

- Powder Coating
- Sand Blast
- Anodised
- Wooden Finish

Glass  
Railing



ENDCAP

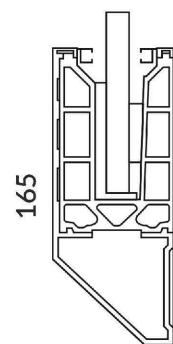

67



AM - 18 BLISS



**Features**

- Rust Free
- Recyclable
- Low Maintenance
- Complete Modular
- Easy to clean

**Specification**

- Continous Profile
- Floor Mounted
- Glass Height up to 1100mm

**Glass**

- 12mm - 15mm Toughened Glass

**Available Finishes**

- Powder Coating
- Sand Blast
- Anodised
- Wooden Finish

Glass Railing

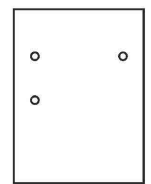

ENDCAP

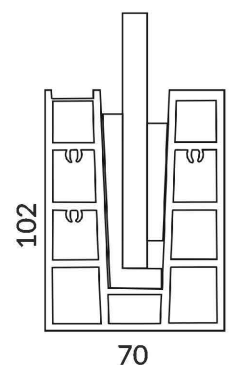

AM - 19 HORIZON



**Features**

- Rust Free
- Recyclable
- Low Maintenance
- Complete Modular
- Easy to clean

**Specification**

- Continuous Profile
- Floor Mounted
- Glass Height up to 1000mm

**Glass**

- 12mm - 14mm Toughened Glass

**Available Finishes**

- Powder Coating
- Sand Blast
- Anodised
- Wooden Finish

Glass  
Railing

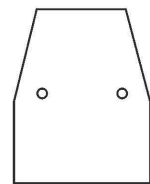

ENDCAP

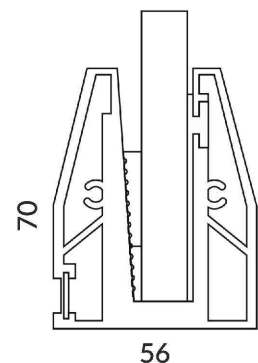



AM - 20 T BRACKETO



**Features**

- Rust Free
- Recyclable
- Low Maintenance
- Complete Modular
- Easy to clean

**Specification**

- Bracketed
- Floor Mounted
- Glass Height up to 1000mm
- Bracket Size : 70mm

**Glass**

- 12mm - 14mm Thick Glass

**Available Finishes**

- Powder Coating
- Sand Blast
- Anodised
- Wooden Finish

# Glass Railing

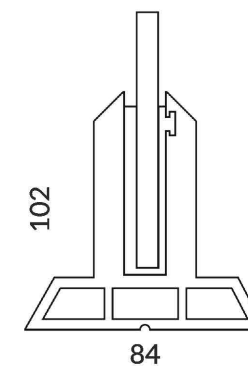



AM - 21 L BRACKETO

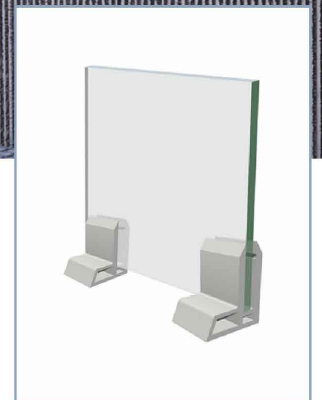

# Glass Railing

### Features

- Rust Free
- Recyclable
- Low Maintenance
- Complete Modular
- Easy to clean

### Specification

- Bracketed
- Floor Mounted
- Glass Height up to 1000mm
- Bracket Size : 70mm

### Glass

- 12mm - 14mm Thick Glass

### Available Finishes

- Powder Coating
- Sand Blast
- Anodised
- Wooden Finish

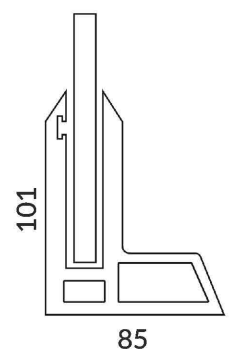



## AM - 22 ORCHID BRACKETO

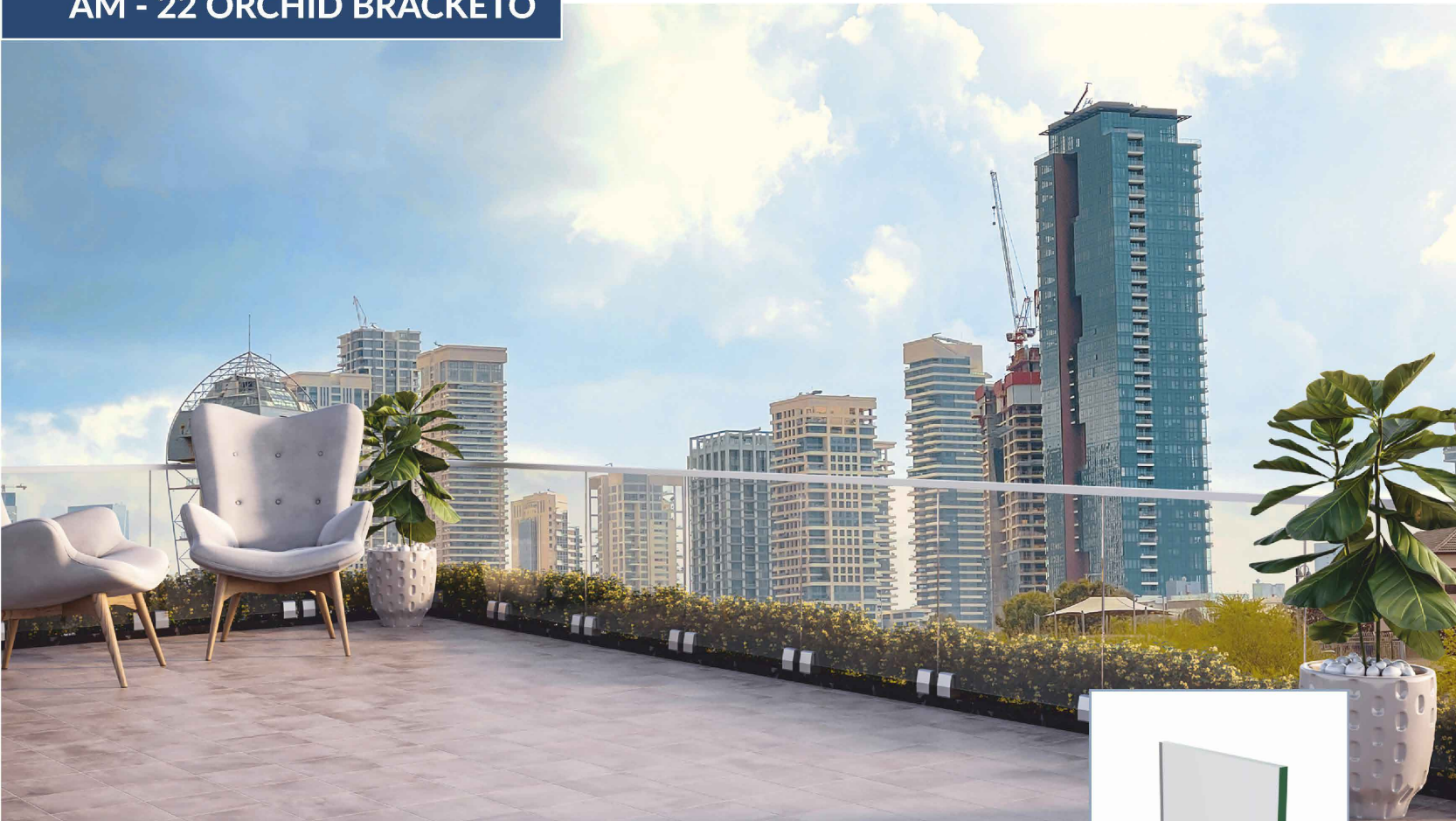

### Features

- Rust Free
- Recyclable
- Low Maintenance
- Complete Modular
- Easy to clean

### Specification

- Bracketed
- Floor Mounted
- Glass Height up to 900mm
- Bracket Size : 70mm

### Glass

- 12mm - 14mm Thick Glass

### Available Finishes

- Powder Coating
- Sand Blast
- Anodised
- Wooden Finish

## Glass Railing

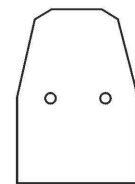
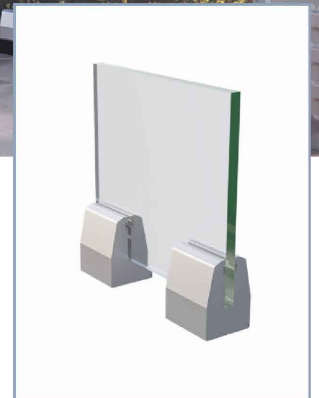

ENDCAP

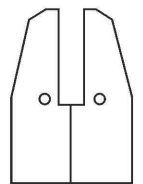

SLOTTED

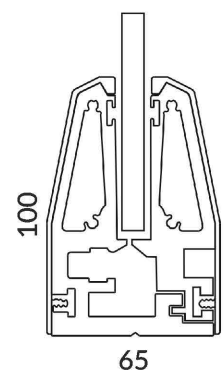



AM - 23 FERRY BRACKETO

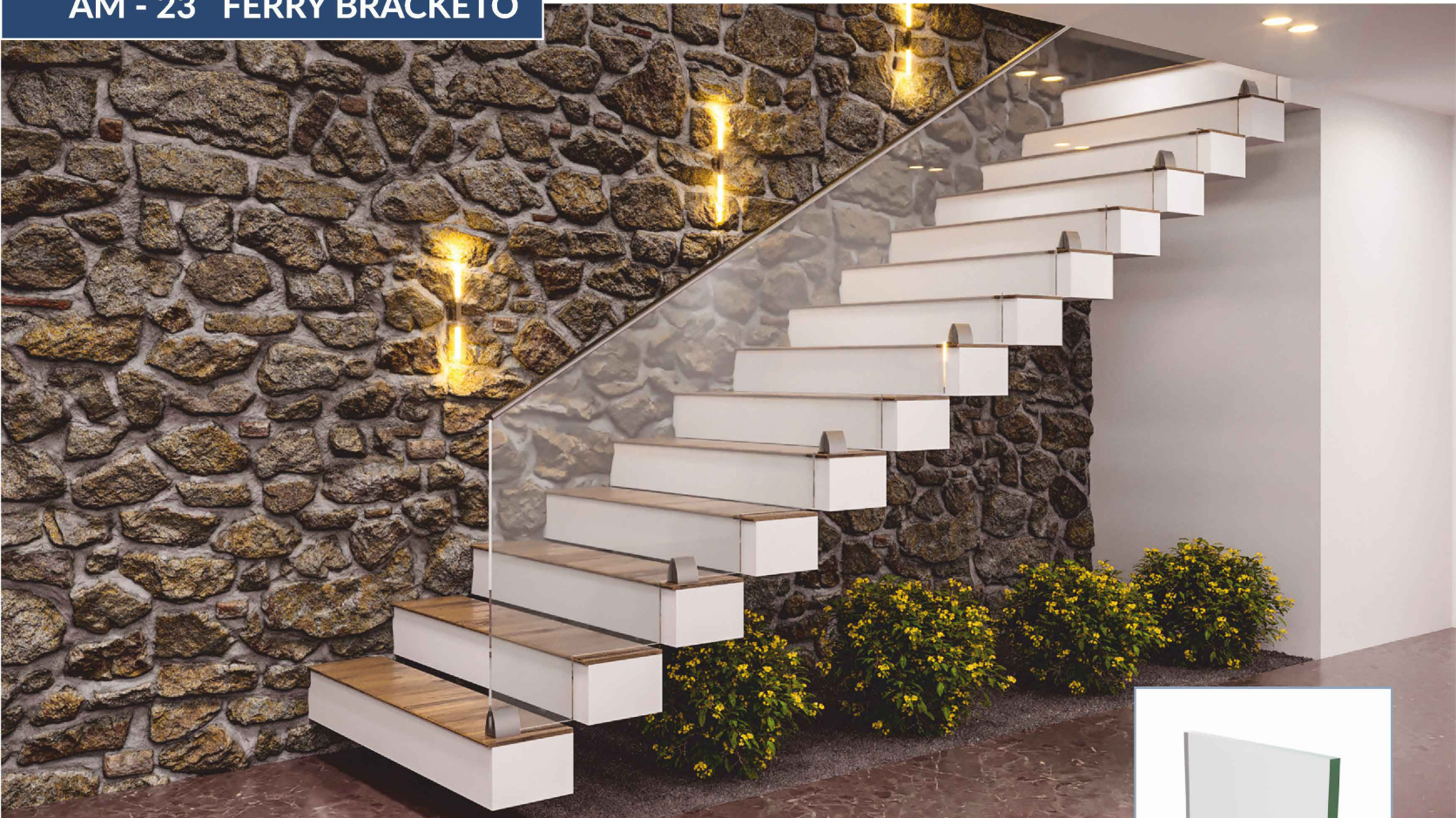

**Features**

- Rust Free
- Recyclable
- Low Maintenance
- Complete Modular
- Easy to clean

**Specification**

- Bracketed
- Floor Mounted
- Glass Height up to 900mm
- Bracket Size : 70mm

**Glass**

- 10mm - 12mm Thick Glass

**Available Finishes**

- Powder Coating
- Sand Blast
- Anodised
- Wooden Finish

Glass Railing

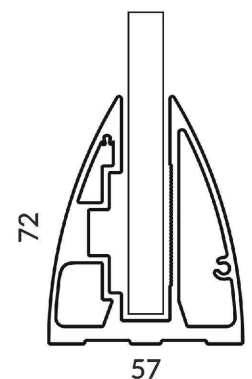
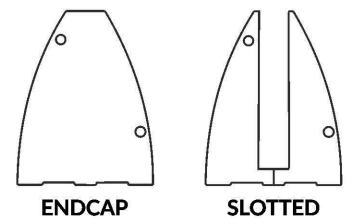
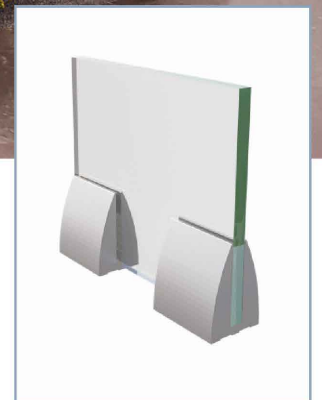



AM - 24 BIG FERRY BRACKETO

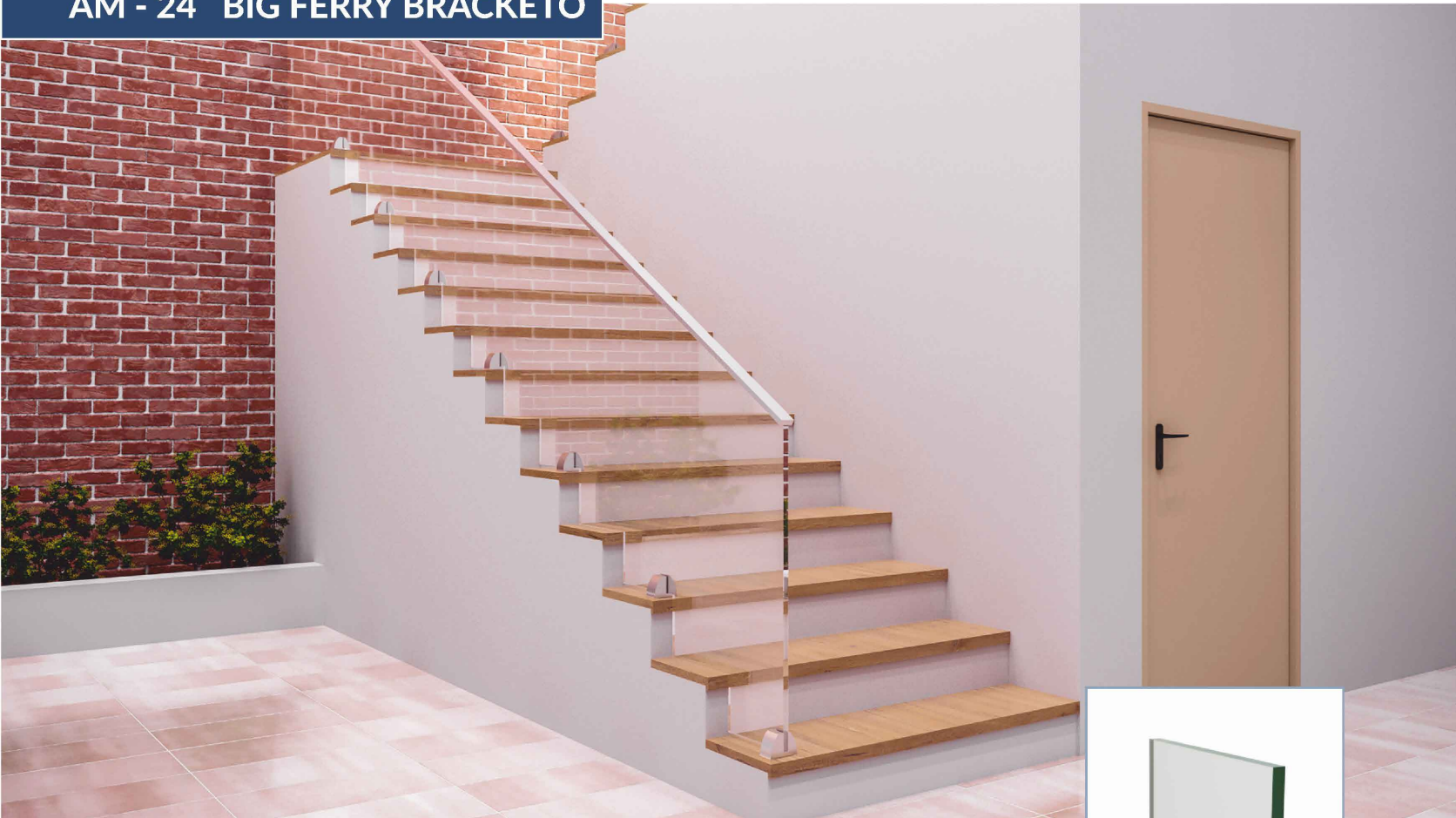

**Features**

- Rust Free
- Recyclable
- Low Maintenance
- Complete Modular
- Easy to clean

**Specification**

- Bracketed
- Floor Mounted
- Glass Height up to 900mm
- Bracket Size : 70mm

**Glass**

- 12mm - 14mm Thick Glass

**Available Finishes**

- Powder Coating
- Sand Blast
- Anodised
- Wooden Finish

**Glass Railing**

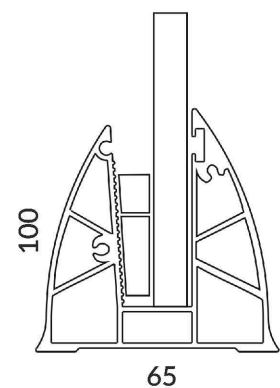
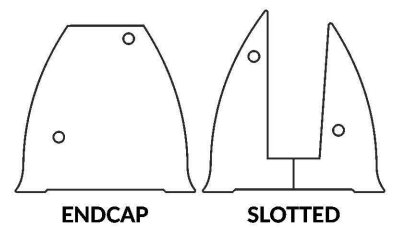

AM - 25 PRIMO BRACKETO



**Features**

- Rust Free
- Recyclable
- Low Maintenance
- Complete Modular
- Easy to clean

**Specification**

- Bracketed
- Floor Mounted
- Glass Height up to 900mm
- Bracket Size : 70mm

**Glass**

- 10mm - 12mm Thick Glass

**Available Finishes**

- Powder Coating
- Sand Blast
- Anodised
- Wooden Finish

Glass Railing

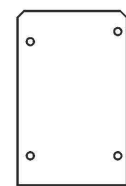
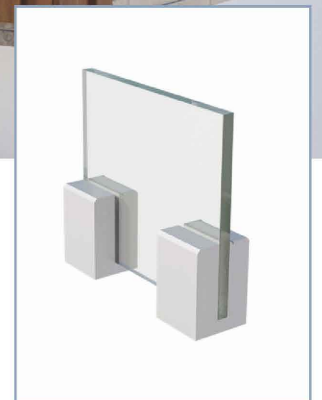

ENDCAP

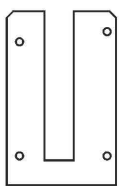

SLOTTED

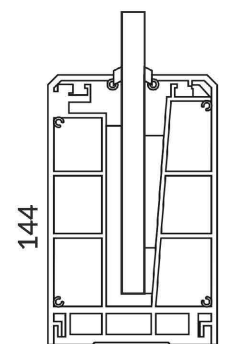

88



AM - 26 ATLAS BRACKETO



**Features**

- Rust Free
- Recyclable
- Low Maintenance
- Complete Modular
- Easy to clean

# Glass Railing



**Specification**

- Bracketed
- Floor Mounted
- Glass Height up to 900mm
- Bracket Size : 70mm

**Glass**

- 12mm - 14mm Thick Glass

**Available Finishes**

- Powder Coating
- Sand Blast
- Anodised
- Wooden Finish

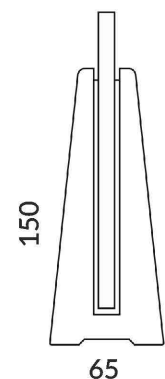

## Hand Rail & Accessories

Material Grade : Aluminium 6063



**SLIM PIPE**

Specification :  
Size : 17mm x 17mm  
Size : 25mm x 25mm  
With accessories

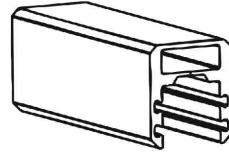

Pipe

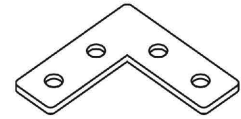

Bend

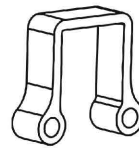

Wall Conceal



Cap

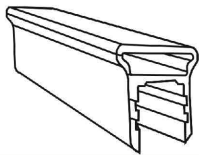

Pipe

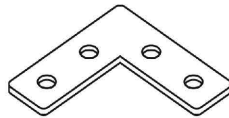

Bend



Wall Conceal

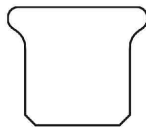

Cap

Specification :  
Size : 27 mm x 32 mm  
With accessories

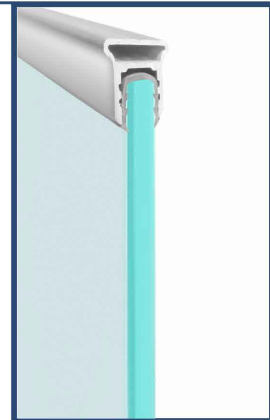

**SLEEK PIPE**



**FLAME PIPE**

Specification :  
Size : 36 mm x 41 mm  
With accessories



Wall Conceal

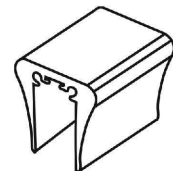

Pipe



Cap



## Hand Rail & Accessories

Material Grade : Aluminium 6063



**ROUND PIPE**

Specification :  
Size : 65mm Dia  
Size : 50mm Dia  
With accessories

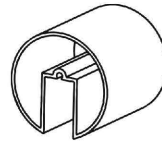

Pipe

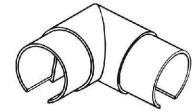

Bend



Wall Conceal



Cap

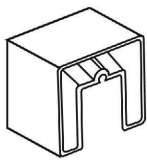

Pipe

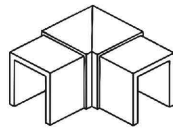

Bend

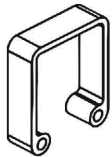

Wall Conceal

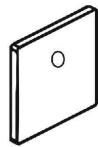

Cap

Specification :  
Size : 40 mm x 40 mm  
Size : 50 mm x 50 mm  
With accessories



**SQUARE PIPE**



**OVAL PIPE**

Specification :  
Size : 30mm x 60mm  
Size : 35mm x 65mm  
Size : 45mm x 70mm  
With accessories

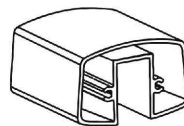

Pipe



Bend



Wall Conceal



Cap

## Hand Rail & Accessories

Material Grade : Aluminium 6063

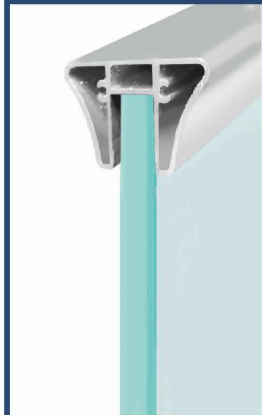

**TRIANGLE PIPE**

Specification :  
Size : 40mm x 65mm  
With accessories

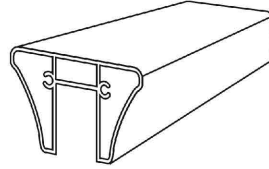

Pipe

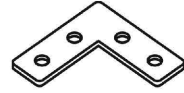

Bend



Wall Conceal

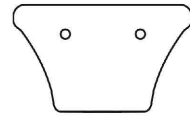

Cap

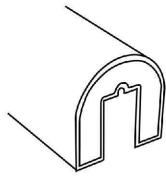

Pipe

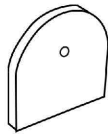

Cap

Specification :  
Size : 55 mm x 55 mm  
With accessories



**U PIPE**



**INCLINED PIPE**

Specification :  
Size : 32mm x 88mm  
With accessories

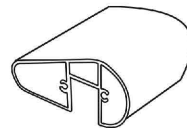

Pipe

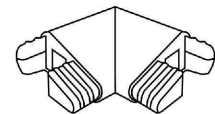

Bend

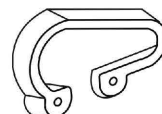

Wall Conceal

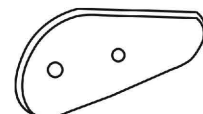

Cap



## LED Hand Rail & Accessories

Material Grade : Aluminium 6063

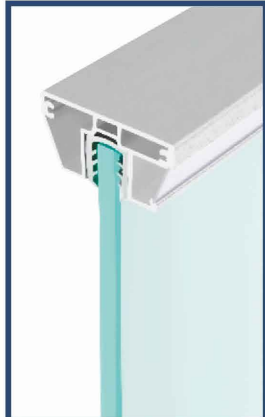

**LED PIPE**

Specification :  
Size : 34mm x 70mm  
With accessories

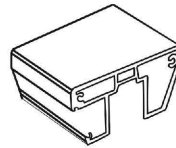

Pipe

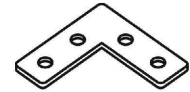

Bend

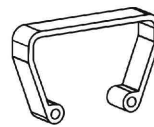

Wall Conceal

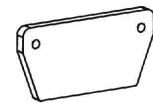

Cap

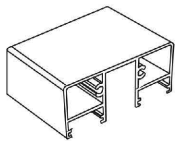

Pipe

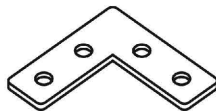

Bend

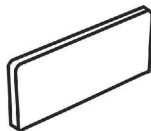

Cap

Specification :  
Size : 30 mm x 70 mm  
With accessories



**RECTANGULAR LED PIPE**

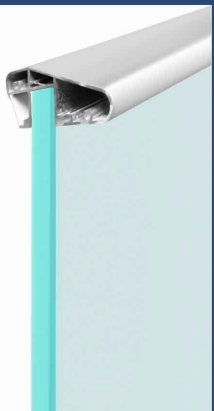

**INCLINED LED PIPE**

Specification :  
Size : 35mm x 85mm  
With accessories

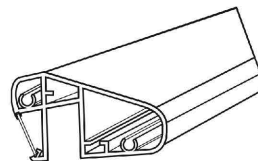

Pipe

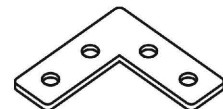

Bend

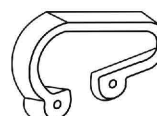

Wall Conceal

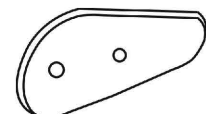

Cap

Available Finish

**Powder Coated Finish**



Silver Grey



Anodic Bronze



Thunder Black



Semi Glossy  
White

**Sand Blast Finish**



Silver



Champagne



Black

**Wooden Finish**



01

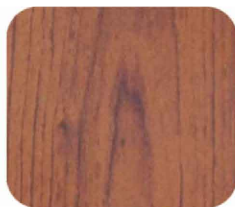

02



03



04



05

**PVD Finish (Steel)**



Rose Gold



Gold

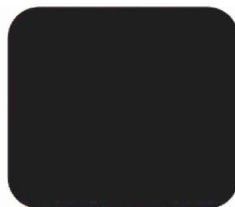

Matt Black



Copper



Grey

Note : Please Enquire for any kind of Customize Finish



## Other Products

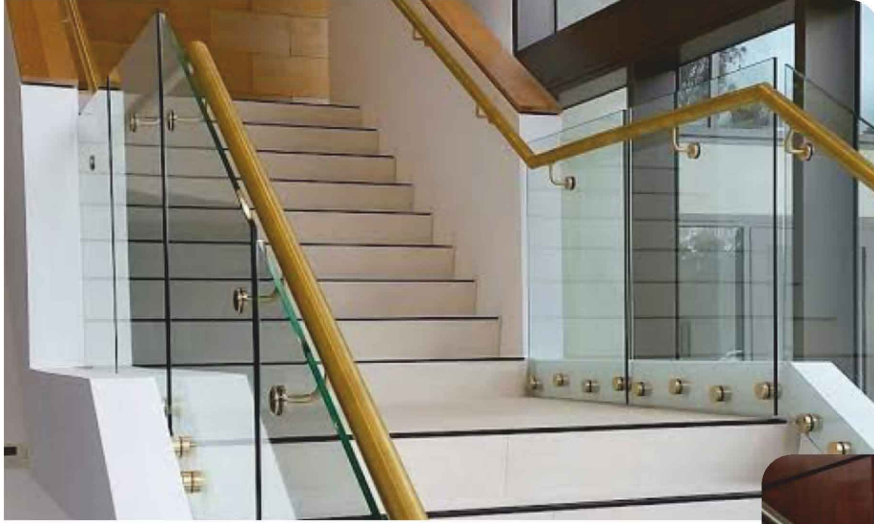

### PVD FINISH

PVD stands for Physical Vapour Deposition. During the PVD coating process, a top layer is applied over the base material of our products by evaporation at temperatures up to 500 degrees Celsius.

### STAINLESS STEEL

304-Grade Stainless Steel may be the best choice for a railing system designed for both indoors and outdoors - especially if your application is away from large bodies of salt water and won't be exposed to extreme conditions.

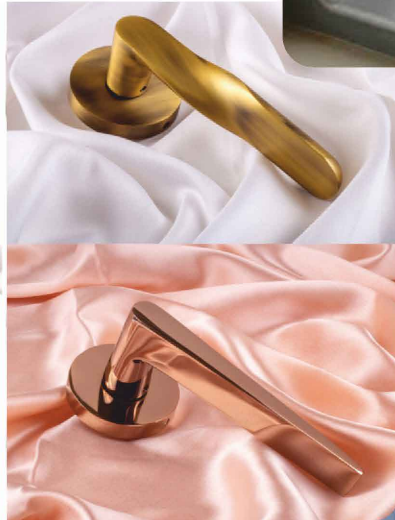

### BRASS MORTICE HANDLE

Brass is durable and resistant to corrosion, making it an attractive option from early on in the door-knob-making process with unique finishing options.

### INVISIBLE GRILL

Invisible Grills are probably the safest window grill options you can buy in the market today. While they may be popular mainly for the fact that they unblock your view, you do not need to compromise your safety.

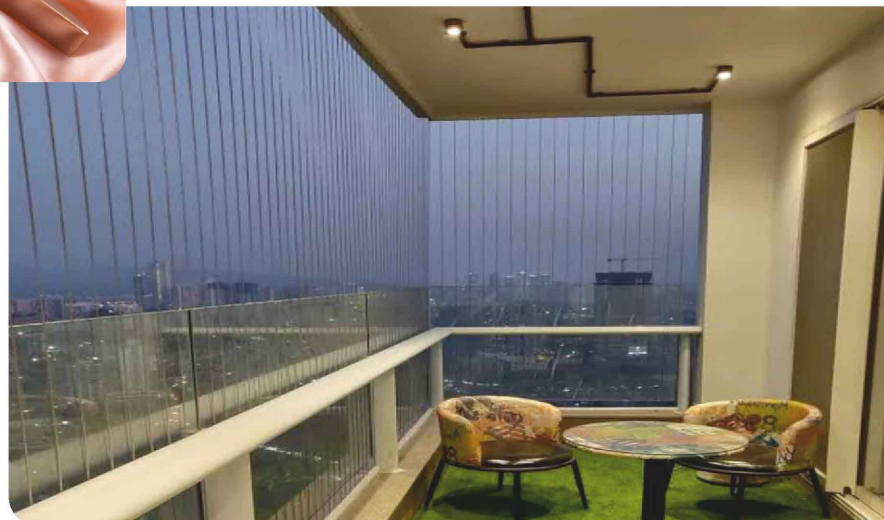



**ALLMARK**<sup>TM</sup>

📍 **Office :**  
1128, RK World Tower,  
Sheetal Park,  
150ft Ring Road,  
Rajkot-05(Gujarat) INDIA

🏭 **Factory :**  
Loha nagar,  
Nr. BSNL Telephone Exchange,  
Gondal Road,  
Rajkot (Gujarat) INDIA

☎ +91 - 81550 70121  
☎ +91 - 81550 70153  
✉ info@theallmark.com  
🌐 www.theallmark.com  
🌐 www.metalogroup.com

follow us



JAY SHREE SHYAM